

Yes, you can.®

 Invacare NV
 Autobaan 22 - 8210 Loppem - België - www.invacare.be

Invacare® Action³ NG Light

Manuele Standaard en modulaire rolstoel met vouwbaar frame

 Maximaal gebruikersgewicht: 125 kg.
 Algemene garantie: 1 jaar; garantie op het frame: 3 jaar

Datum:

Referentie:

Verdelers:

 Gelieve uw keuze aan te geven door een kruisje in het vierkantje

 Standaard optie







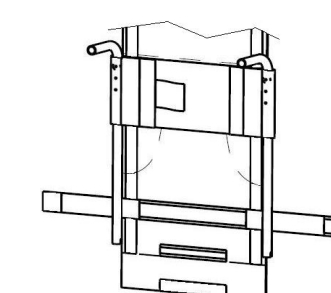
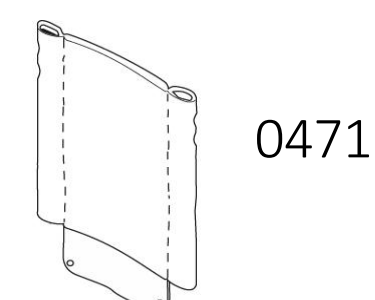

 Optie zonder meerprijs

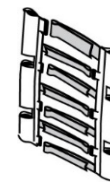
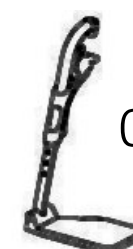
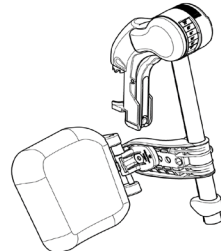

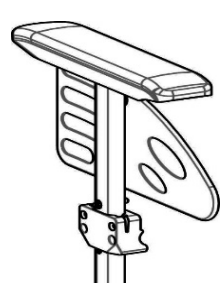







CODE		OMSCHRIJVING		Publieke prijs in €, 6% BTW inbegrepen
CES0026	<input checked="" type="checkbox"/>	Invacare® Action ³ NG Light (ongeveer 1,22 kg lichter)		975,00
CESSPEC	<input type="checkbox"/>	Speciale uitvoering		Op aanvraag
AANDRIJVING				
CES0100	<input checked="" type="checkbox"/>	Hoepelaandrijving		
CES0110	<input type="checkbox"/>	Transitversie (12" achterwielen - vaste as - passieve achterwielpositie)	(NC : 0251, 0290, 0300, 0310, 0315, 0428, 0431, 0511, 0561, 0738, 0739, 1054, 1056, 1064, 1066, 1068, 1075, 1140, 1150, 1151, 1180, 1181, 1182, 1183, 1185, 1190, 1212, 1260, 1261, 1275, 1320, 1330, 1331, 1332, 1365, 1390)	
ZITTING				
ZITBREEDTE				
CES0180	<input type="checkbox"/>	380 mm	NC 0251, 0372, 0421, 0441, 0442, 0852, 0855, 1481	
CES0190	<input type="checkbox"/>	405 mm	NC 0251	
CES0200	<input type="checkbox"/>	430 mm	NC 0853	
CES0210	<input checked="" type="checkbox"/>	455 mm	NC 0853	
CES0220	<input type="checkbox"/>	480 mm	NC 0372, 0421, 0441, 0442, 0881, 0852, 0853, 0854, 1481	
CES0230	<input type="checkbox"/>	505 mm	NC 0852, 0853, 0854, 0855, 0856	275,32
ZITDIEPTE				
CES0240	<input checked="" type="checkbox"/>	400 mm	NC 0879	
CES0250	<input type="checkbox"/>	450 mm	NC 0853, 0878	
CES0251	<input type="checkbox"/>	500 mm	NC 0330, 0350	
CES0252	<input type="checkbox"/>	Instelbaar 400-450 mm	NC 0330, 0350	
ZITHOOGTE				
CES0260	<input checked="" type="checkbox"/>	510 mm	NC 0511, 0561, 0738, 0739, 0838, 0839, 1049, 1050, 1051, 1052, 1100, 1110, 1117	
CES0270	<input type="checkbox"/>	485 mm	NC 0511, 0561, 1051	
CES0280	<input type="checkbox"/>	460 mm		
CES0290	<input type="checkbox"/>	435 mm	NC 0660/0670/0760/0770 + 24", 1005, 1010, 1020, 1030	
CES0300	<input type="checkbox"/>	410 mm	NC 0511, 0561, 0660/0670/0760/0770 + 24", 0935, 1005, 1010, 1020, 1030, 1052, 1365, 1370, 1440	
CES0310	<input type="checkbox"/>	385 mm (enkel met lage vork, voorwiel 5 x1 1/4 vol en achterwiel 22")	NC 0511, 0561, 0660, 0670, 0738, 0739, 0760, 0770, 0838, 0839, 0935, 1005, 1010, 1020, 1030, 1049, 1050, 1052, 1060, 1070, 1080, 1081, 1090, 1095, 1099, 1114, 1118, 1119, 1280, 1365, 1370, 1440	







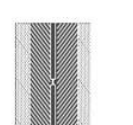

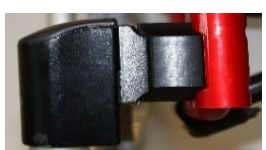

CODE		OMSCHRIJVING		Publieke prijs in €, 6% BTW inbegrepen
CES0315	<input type="checkbox"/>	360 mm (enkel met lage vork, voorwiel 5" vol en 20 x 13/8 " volle gespaakte achterwielen)	NC 0511, 0561 , 0600, 0620, 0660, 0670, 0738, 0739, 0760, 0770, 0838, 0839, 0935, 1280, 1365, 1375, 1440	
ZITBEKLEDING				
CES0330	<input type="checkbox"/>	Nylon zonder velcrostroken		
CES0340	<input checked="" type="checkbox"/>	Nylon met velcrostroken		
CES0345	<input type="checkbox"/>	Naspanbare zit		178,58
CES0350	<input type="checkbox"/>	Met geïntegreerde schuimlaag		
CES0365	<input type="checkbox"/>	Basisplaat met Flotech lite kussen	(NC : 0461, 0462, 0463, 0464, 0466, 0738, 0739, 0838, 0839, 0852, 0908, 0952, 1345, 1346)	260,45
CES0367	<input type="checkbox"/>	Basisplaat	(NC : 0738, 0739, 0838, 0839, 0849, 0851, 0852, 0853, 0854, 0855, 0856, 0869, 0871, 0873, 0874, 0875, 0876, 0852, 0908, 0952, 1345, 1346)	129,48
RUGLEUNING				
Anti-tip wordt aangeraden bij hoekverstelbarerugleuning (430, 435, 440, 441, 442, 445, 450)				
CES0396	<input type="checkbox"/>	Vast, 7°; hoogteverstelbaar 380/460 mm (geleverd 380 mm); hoogteverstelbare duwhandvatten (enkel met rug nylon sling 0471)	NC 0461, 0462, 0463, 0464, 0474, 0477, 0478, 0481, 0905, 0906, 0907, 0908, 0940, 1451	
CES0410	<input type="checkbox"/>	Vast, 7°; hoogte 400/430 mm (geleverd 430 mm); vaste duwhandvatten	NC 0471, 0477, 0945	
CES0420	<input type="checkbox"/>	Vast, 7°; hoogte 510 mm; vaste duwhandvatten		
CES0425	<input checked="" type="checkbox"/>	Vaste, 7°; 430 mm; hoogte verstelbare duwhandvaten (150 mm)	NC : 0471, 0477, 0945, 1346	
CES0431	<input type="checkbox"/>	Hoek instelbaar -15° tot 15° en neerklapbaar; vast 7°, Hoogte 325-350 mm / 14" met vaste korte duwhandvaten	NC 0465, 0471, 0474, 0475, 0478, 0481, 0738, 0780, 0790, 0882, 0905, 0940, 1345, 1451	192,50
CES0432	<input type="checkbox"/>	Hoek instelbaar -15° tot 15° en neerklapbaar; vast 7°, Hoogte 425-450 mm / 17" met vaste lange duwhandvaten	NC 0465, 0471, 0474, 0475, 0478, 0481, 0738, 0780, 0790, 0882	192,50
CES0435	<input type="checkbox"/>	Hoekverstelbaar 0° tot 30°; hoogte instelbaar 390/410/430 mm enkel met passieve wielpositie	NC 0471, 0477, 0738, 0739, 0940, 0945, 1185, 1190	372,05
CES0455	<input type="checkbox"/>	Neerklapbaar hoogte 430 mm, vaste duwhandvatten	NC 0471, 0477, 0945	
CES0460	<input type="checkbox"/>	Neerklapbaar hoogte 510 mm vaste duwhandvatten	NC 0471, 0477, 0481, 0945	
MATRX BACK (VERLIES VAN CA. 20 MM ZITDIEPTE BIJ VERLAAGDE GASVEER RUGLEUNING)				
5 dagen extra levertijd				
CES0461	<input type="checkbox"/>	MatrX Elite E2 rug met bevestigingen; 405mm hoogte		750,00
CES0462	<input type="checkbox"/>	MatrX Elite E2 rug met bevestigingen; 455mm hoogte	(NC: 0465, 0471, 0474, 0475, 0478, 0479, 0480, 0481, 0490, 0491, 0511, 0561, 0691, 0791, 0881, 0882, 0940, 0945, 0952, 1481)	750,00
CES0463	<input type="checkbox"/>	MatrX Elite E2 Deep rug met bevestigingen; 405mm hoogte		850,00
CES0464	<input type="checkbox"/>	MatrX Elite E2 Deep rug met bevestigingen; 455mm hoogte		850,00
MATRX BACK KEUZE BREEDTE				
CES0482	<input type="checkbox"/>	360 mm	Indicatieve borst breedte 265 mm	
CES0483	<input type="checkbox"/>	380 mm	Indicatieve borst breedte 290 mm	
CES0484	<input type="checkbox"/>	410 mm	Indicatieve borst breedte 315 mm	
CES0485	<input type="checkbox"/>	430 mm	Indicatieve borst breedte 340 mm	
CES0486	<input type="checkbox"/>	460 mm	Indicatieve borst breedte 370 mm	
CES0487	<input type="checkbox"/>	480 mm	Indicatieve borst breedte 390 mm	
CES0488	<input type="checkbox"/>	510 mm	Indicatieve borst breedte 420 mm	
RUGBEKLEDING				
CES0471	<input type="checkbox"/>	Nylon Sling (Jemima)	NC 0882, 0905, 0882	
CES0474	<input type="checkbox"/>	Met lumbale steun (1 strap), gepolsterd, 2 materialen, met zakje		
CES0475	<input checked="" type="checkbox"/>	Met lumbale steun (1 strap), gepolsterd		

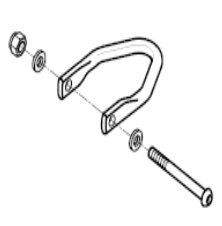
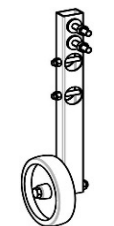
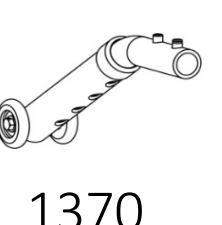
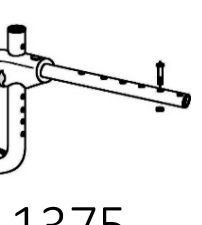

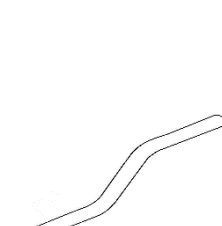
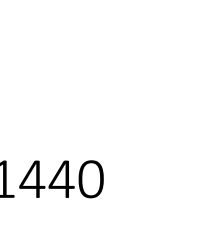
0474 / 0475

CODE		OMSCHRIJVING		Publieke prijs in €, 6% BTW inbegrepen	
CES0477	<input type="checkbox"/>	Naspanbaar (3+1 straps), gepolsterd, 2 materialen, met zakje (zonder rugstang) ENKEL voor hoekinstelbare rug -15° tot 15°	850g meer dan de standaard rugbuizen		
CES0478	<input type="checkbox"/>	Naspanbaar (3+1 straps), gepolsterd, 2 materialen, met zakje (incl. rugfixatiestang)	NC 0940, 0945	178,58	 0481
CES0481	<input type="checkbox"/>	Naspanbaar (7+1 straps) gepolsterd, 2 materialen, met zakje (incl. rugfixatiestang)	NC 0940, 0945	178,58	
VOETSTEUNEN / BEENSTEUNEN					
CES0500 CES0550	<input type="checkbox"/>	Zonder beensteunen	Zonder voetplaten		
CES0510 CES0560	◆	Voetsteunen 80°			 0510 / 0560
CES0511 CES0561	<input type="checkbox"/>	Voetsteunen 90°	NC: 0600, 0936, 1005, 1010, 1020, 1030, 1049, 1050, 1052/ enkel met zithoogte 435 en 460mm		 0520 / 0570
CES0520	<input type="checkbox"/>	Beensteun (0-75°) met kuitsteun, rechts	NC 0611, 0930, 0936	171,15	
CES0570	<input type="checkbox"/>	Beensteun (0-75°) met kuitsteun, links	NC 0611, 0930, 0937	171,15	
CES0545	<input type="checkbox"/>	Amputatiesteun, rechts	NC 0600, 0610, 0611, 0930, 0936	137,50	
CES0595	<input type="checkbox"/>	Amputatiesteun, links	NC 0600, 0610, 0611, 0930, 0937	137,50	 0545 / 0595
VOETPLATEN PER PAAR					
CES0600 CES0620	◆	Standaard, opklapbaar met hielband			
CES0610 CES0630	<input type="checkbox"/>	Opklapbaar, hoek en diepte instelbaar met hielband		133,95	
CES0611	<input type="checkbox"/>	Eendelig, hoek en diepte instelbaar	NC 0620, 0630, 0935, 0936	267,46	
ARMSTEUNEN ALTIJD IN ZWART (PER PAAR)					
CES0640 CES0740	◆	Afneembaar, kort, hoogteverstelbaar en autolock 200 tot 280 mm	NC 0760, 0770, 0780, 0790, 0795, 0796, 0838, 0839, 1480		 0640 / 0740
CES0650 CES0750	<input type="checkbox"/>	Afneembaar, lang, hoogteverstelbaar en autolock 200 tot 280 mm	NC 0760, 0770, 0780, 0790, 0795, 0796, 0838, 0839		
CES0660 CES0760	<input type="checkbox"/>	Opklapbaar, afneembaar, kort; hoogte 240 mm	NC 0740, 0750, 0780, 0790, 0795, 0796, 0838, 0839, 1480		 0660 / 0760
CES0670 CES0770	<input type="checkbox"/>	Opklapbaar, afneembaar, lang, hoogte 240 mm	NC 0740, 0750, 0780, 0790, 0795, 0796, 0838, 0839		
CES0680 CES0780	<input type="checkbox"/>	Opklapbaar, afneembaar, kort, hoogteverstelbaar	NC 0740, 0750, 0760, 0770, 0795, 0796, 0838, 0839, 1480		 0680 / 0780
CES0690 CES0790	<input type="checkbox"/>	Opklapbaar, afneembaar lang, hoogte & diepte verstelbaar	NC 0740, 0750, 0760, 0770, 0795, 0796, 0838, 0839		
CES0695 CES0795	<input type="checkbox"/>	Afneembaar, hoogte & diepte verstelbaar, tafelfunctie en autolock	NC 0740, 0750, 0760, 0770, 0780, 0790, 0838, 0839, 1185, 1480	350,00	 0695 / 0795
CES0696 CES0796	<input type="checkbox"/>	Afneembaar, hoogte & diepte verstelbaar, lang en autolock	NC 0740, 0750, 0760, 0770, 0780, 0790, 0838, 0839, 1185	350,00	
CES0732	<input type="checkbox"/>	Hemiplegie armlegger rechts met autolock (altijd samen met hoogte instelbare armsteun)	NC 0838, 0839, 1185	350,00	
CES0832	<input type="checkbox"/>	Hemiplegie armlegger links met autolock (altijd samen met hoogte instelbare armsteun)	NC 0838, 0839, 1185	350,00	
CES0738 CES0838	<input type="checkbox"/>	Afneembaar, hoogteverstelbaar spatbord (155-220mm)	NC 0740, 0750, 0760, 0770, 0780, 0790, 0795, 0796, 0832, 0839, 1100, 1110, 1116, 1117, 1200, 1201, 1480	350,00	
CES0739 CES0839	<input type="checkbox"/>	Buisvormige armleggers; swing away met afneembare kledingbeschermer	NC 0740, 0750, 0760, 0770, 0780, 0790, 0795, 0796, 0832, 0838, 1100, 1110, 1116, 1117, 1200, 1201, 1345, 1430, 1365, 1480	350,00	
ZITOPTIES					
ZITKUSSEN					
CES0849	<input type="checkbox"/>	Standaard			 0849
CES0869	<input type="checkbox"/>	Matrx Flo-tech Lite	NC 0883	137,50	
CES0871	<input type="checkbox"/>	Matrx Flo-tech Contour Visco	NC 0883	148,82	
CES0873	<input type="checkbox"/>	Matrx Flo-tech Image	NC 0883	520,89	 0873
CES0874	<input type="checkbox"/>	Matrx Flo-tech Solution Xtra	NC 0883	595,29	

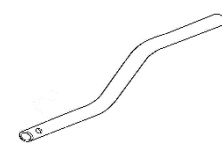
CODE		OMSCHRIJVING		Publieke prijs in €, 6% BTW inbegrepen		
CES0876	<input type="checkbox"/>	Matrx Flo-tech Libra		520,89		
ZITDIEPTE						
CES0878	<input type="checkbox"/>	400 mm				
CES0879	<input type="checkbox"/>	450 mm				
CES0883	<input type="checkbox"/>	500 mm				
ANDERE ZITOPTIES						
CES0852	<input type="checkbox"/>	Seat rigidizer		105,00		
CES0882	<input type="checkbox"/>	Laterale positioneringskussens (paar)		220,00	 0882	
CES0905	<input type="checkbox"/>	Neksteun Dartex incl. Rugfixatiestang	NC 0906, 0907, 0908, 0940, 0945	223,22	 0905	
CES0930	<input type="checkbox"/>	Kuitband, verstelbaar				
CES0935	<input type="checkbox"/>	Langere voetbuis (UL 450-530 mm)	NC 0936			
CES0936	<input type="checkbox"/>	Kortere voetbuis (UL 230-430 mm)				
CES0937	<input type="checkbox"/>	Ankle huggers Bodypoint M		220,00		
CES0938	<input type="checkbox"/>	Ankle huggers Bodypoint L		220,00		
CES0940	<input type="checkbox"/>	Rugfixatiestang	NC 0945	66,00		
CES0945	<input type="checkbox"/>	Vouwbare rugstabilisatiestang	NC 1451	99,00		
FRAMEKLEUREN						
CES0961	<input type="checkbox"/>	LEIGRIJS			 0961 / 0964 / 0965 / 0966	
CES0964	<input type="checkbox"/>	PARELWIT				
CES0965	<input type="checkbox"/>	ELEKTRISCH GROEN			 0974 / 0976 / 0969 / 0980	
CES0966	<input type="checkbox"/>	MAT ZWART				
CES0969	<input type="checkbox"/>	MAT ROOD			 0972	
CES0972	<input type="checkbox"/>	APPELBLAUWZEEGROEN				
CES0974	<input type="checkbox"/>	MARINE BLAUW				
CES0976	<input type="checkbox"/>	DONKERPAARS				
CES0980	<input checked="" type="checkbox"/>	ANTHRACIET ZWART				
CES0991	<input type="checkbox"/>	SPECIALE KLEUR		Op aanvraag		
VOORWIELBEVESTIGING						
CES0996	<input checked="" type="checkbox"/>	Light bevestiging (-400g)				
VOORWIELEN						
CES1005	<input type="checkbox"/>	8" x 1 ¼"; lucht; zwarte band			 1010	
CES1010	<input checked="" type="checkbox"/>	8" x 1 ¼"; Vol; zwarte band				
CES1030	<input type="checkbox"/>	8" x 2"; Vol; zwarte band			 1050	
CES1035	<input type="checkbox"/>	6" x 1 ¼"; Vol, medium hard; zwart				
CES1050	<input type="checkbox"/>	6" x 1 ¼"; Vol; zwarte band	Niet met 12" achterwielen			
CES1054	<input type="checkbox"/>	5" x 1 "; Vol; zwart	NC: 1062			
CES1056	<input type="checkbox"/>	5" 1/2 x 1" 3/4; Vol, medium hard; zwart	NC: 1062			
ACHTERWIELEN						
MAAT						
CES1062	<input type="checkbox"/>	12" / 305 MM	(NC : 1071, 1072, 1075, 1076, 1084, 1088, 1092, 1140, 1150, 1151, 1180, 1181, 1182, 1183, 1185, 1190, 1260, 1261, 1320, 1330, 1331, 1332, 1380, 1390)			
CES1064	<input type="checkbox"/>	20" / 515 MM				
CES1066	<input type="checkbox"/>	22" / 560 MM				
CES1068	<input checked="" type="checkbox"/>	24" / 600 MM				
TYPE WIELEN						
CES1074	<input type="checkbox"/>	Composite wiel	NC : 1088, 1092, 1380		 Composite	
CES1076	<input checked="" type="checkbox"/>	Light wiel (zwarte naaf en hub; radiaal gespaakt)	NC : 1170, 1201, 1230, 1260, 1261, 1331, 1332			
TYPE BANDEN						
CES1082	<input checked="" type="checkbox"/>	Volle zwarte band 35 MM (1"3/8)			 1088	
CES1084	<input type="checkbox"/>	Geprofileerde zwarte luchtband 35 MM (1"3/8)				 1084
CES1088	<input type="checkbox"/>	Luchtband laag profiel, zwart 25 MM (1")				
CES1092	<input type="checkbox"/>	Maxxis Alpha Protect luchtband 25 MM		100,00		
HOEPELS						
CES1140	<input checked="" type="checkbox"/>	Aluminium hoepels, geanodiseerd				
CES1150	<input type="checkbox"/>	Plastic gecoate hoepels, anti-slip		115,33		
ACHTERWIELASSEN						
CES1170	<input type="checkbox"/>	Vaste achterwielassen	NC 1185, 1365			
CES1180	<input checked="" type="checkbox"/>	QR achterwielassen				
ACHTERWIELPOSITIE						
CES1185	<input type="checkbox"/>	Actieve achterwielpositie	NC 1320, 1330, 1345, 1365			
CES1190	<input checked="" type="checkbox"/>	Standaard achterwielpositie				
CES1200	<input type="checkbox"/>	Passieve achterwielpositie				
CES1201	<input type="checkbox"/>	Amputatie achterwielaanpassing	NC 1275, 1280, 1320, 1330, 1365	129,48		

CODE		OMSCHRIJVING		Publieke prijs in €, 6% BTW inbegrepen	
FRAME OPTIES					
CES1230	<input type="checkbox"/>	Pomp met bevestigingsklemmen		22,00	 1241
CES1241	<input type="checkbox"/>	Voorwielverlenging (+50 mm naar buiten)			
CES1260	<input type="checkbox"/>	Spaakbeschermers voor 24" wielen - zwart (paar)		154,00	
CES1261	<input type="checkbox"/>	Spaakbeschermers voor 22" wielen - doorzichtig (paar)		154,00	
REMMEN					
CES1270	<input checked="" type="checkbox"/>	Duwremmen			 1270
CES1275	<input type="checkbox"/>	Trekremmen			
VEILIGHEIDSOPTIES					
CES1345	<input type="checkbox"/>	Transportkit (bevestigingspunten)	NC: 1360, 1363, 1364	44,00	          
CES1360	<input type="checkbox"/>	Veiligheidsgordel	NC 1361, 1362, 1363, 1364	44,65	
CES1361	<input type="checkbox"/>	BodyPoint 2-puntsgordel Medium	NC 1362, 1363, 1364	242,00	
CES1362	<input type="checkbox"/>	BodyPoint 2-puntsgordel Large	NC 1363, 1364	242,00	
CES1363	<input type="checkbox"/>	BodyPoint 4-puntsgordel Medium	NC 1364	264,00	
CES1364	<input type="checkbox"/>	BodyPoint 4-puntsgordel Large		264,00	
CES1365	<input type="checkbox"/>	Transferwielen (4")		165,00	
CES1370	<input type="checkbox"/>	Anti-tip per paar	NC 1375, 1440, 1441	74,42	
CES1375	<input type="checkbox"/>	Anti-tip met trapdop per paar (type Rea)	NC 1440, 1441	74,42	
CES1380	<input type="checkbox"/>	Reflectorskit (wielen + frame achteraan)		33,00	
CES1390	<input type="checkbox"/>	Remverlengers per paar		22,30	
ACCESSOIRES					
CES1430	<input type="checkbox"/>	Stokhouder		49,50	 1440
CES1440	<input checked="" type="checkbox"/>	Trapdop rechts			
CES1441	<input type="checkbox"/>	Trapdop links			
CES1451	<input type="checkbox"/>	Infuushouder met bevestigingsset (enkel met rugfixatiestang)		137,50	
OVERIGE OPTIES					
CES1480	<input type="checkbox"/>	Werkblad		238,11	 1480